

Programmable Display

# TECHNOSHOT



Feel the difference  
in power of expression,  
speed and networking capability.

MONITOUCH





# MONITOUCH TECHNOSHOT



## Communication technology drives innovation in every industry.

Our MONITOUCH programmable displays have been used in various fields - airplane, railway and power plant control systems, electronically controlled order systems for restaurants, factory automation systems, etc. With its sophisticated communication technology, the "TECHNOSHOT" series accelerates development in all industries.



Compact yet highly functional

## TS1070 series



TS1070 Model  
 TS1070□ Functional specifications: NA: Without built-in LAN port i: With built-in LAN port

### Specifications

Model		TS1070i	TS1070
Display	Display size	7" Wide	
	Resolution	800 × 480 dots	
	Display device	TFT color LCD	
	Colors	65,536 colors	
	Backlight	LED	
	Luminance	450 cd/m <sup>2</sup>	
Touch switch	Analog resistance film		
Memory	FROM	10.5 MB	
	SRAM	128 KB	
External interface	Serial	COM1	RS-422/485, Asynchronous, Data length: 7,8 bits, Parity: even/odd/none, Stop bit: 1,2 bits Baud rate: 4800/9600/19200/38400/57600/76800/115200/187500*1 bps
		COM2 & COM3	RS-232C, Asynchronous, Data length: 7,8 bits, Parity: even/odd/none, Stop bit: 1,2 bits Baud rate: 4800/9600/19200/38400/57600/76800/115200 bps
			RS-422/485(two-wire system), Asynchronous, Data length: 7,8 bits, Parity: even/odd/none, Stop bit: 1,2 bits Baud rate: 4800/9600/19200/38400/57600/76800/115200 bps
	Ethernet	100BASE-TX/10BASE-T	-
	USB (Type A)	1 port (Ver. 2.0, Ver.1.1)	
USB (Type mini B)	1 port (Ver. 2.0, Ver.1.1)		
Clock	Battery	Coin-type lithium primary battery	
	Calendar accuracy	Gap±5 sec. per month (Ambient temperature 25 °C)	
Power supply	Permissible range of voltage	DC 24 V ± 10 %	
	Demand (maximum rating)	16 W or less	
	Ambient operating temperature	0-50 °C*2	
	Ambient storage temperature	-10-60 °C*2	
Physical environment	Relative humidity	85 % RH or less(without dew condensation, Max. wet bulb temperature: 39 °C or less)	
	Operation altitude	2,000 meters or less	
	Operation atmosphere	Not exposed to corrosive gas or excessive dust (free of conductive dust)	
	Contamination level	Level 2	
	Dimensions W × H × D	215.0 × 155.0 × 42.0 mm	
Installation conditions	Panel cutout W × H	189.0 × 134.0 mm (+0.5/-0)	
	Protect structure	Front panel: Compatible with IP65 (when waterproof gasket*3 is used.), Rear cabinet: Compatible with IP20 Form: Single unit, Installation method: Panel mounting	
Case color	Black		
Compatibility	CE, KC		

\*1 Available only when connected with SIEMENS MPI. \*2 Keep wet bulb temperature under 39°C to avoid an accident. \*3 Option

Wide screen to display more information

## TS1100 series



TS1100 Model  
 TS1100□ Functional specifications: NA: Without built-in LAN port i: With built-in LAN port

### Specifications

Model		TS1100i	TS1100
Display	Display size	10.2" Wide	
	Resolution	800 × 480 dots	
	Display device	TFT color LCD	
	Colors	65,536 colors	
	Backlight	LED	
	Luminance	350 cd/m <sup>2</sup>	
Touch switch	Analog resistance film		
Memory	FROM	10.5 MB	
	SRAM	128 KB	
External interface	Serial	COM1	RS-422/485, Asynchronous, Data length: 7,8 bits, Parity: even/odd/none, Stop bit: 1,2 bits Baud rate: 4800/9600/19200/38400/57600/76800/115200/187500*1 bps
		COM2 & COM3	RS-232C, Asynchronous, Data length: 7,8 bits, Parity: even/odd/none, Stop bit: 1,2 bits Baud rate: 4800/9600/19200/38400/57600/76800/115200 bps
			RS-422/485(two-wire system), Asynchronous, Data length: 7,8 bits, Parity: even/odd/none, Stop bit: 1,2 bits Baud rate: 4800/9600/19200/38400/57600/76800/115200 bps
	Ethernet	100BASE-TX/10BASE-T	-
	USB (Type A)	1 port (Ver. 2.0, Ver.1.1)	
USB (Type mini B)	1 port (Ver. 2.0, Ver.1.1)		
Clock	Battery	Coin-type lithium primary battery	
	Calendar accuracy	Gap±5 sec. per month (Ambient temperature 25 °C)	
Power supply	Permissible range of voltage	DC 24 V ± 10 %	
	Demand (maximum rating)	16 W or less	
	Ambient operating temperature	0-50 °C*2	
	Ambient storage temperature	-10-60 °C*2	
Physical environment	Relative humidity	85 % RH or less(without dew condensation, Max. wet bulb temperature:39 °C or less)	
	Operation altitude	2,000 meters or less	
	Operation atmosphere	Not exposed to corrosive gas or excessive dust (free of conductive dust)	
	Contamination level	Level 2	
	Dimensions W × H × D	283.0 × 220.0 × 42.0 mm	
Installation conditions	Panel cutout W × H	257.0 × 199.0 mm (+0.5/-0)	
	Protect structure	Front panel: Compatible with IP65 (when waterproof gasket*3 is used.), Rear cabinet: Compatible with IP20 Form: Single unit, Installation method: Panel mounting	
Case color	Black		
Compatibility	CE, KC		

\*1 Available only when connected with SIEMENS MPI. \*2 Keep wet bulb temperature under 39°C to avoid an accident. \*3 Option

High-level functions, user-friendliness and remote control with dedicated software

## 01 Remote Maintenance i series only

Data in a TS panel can be monitored and controlled from a remote office at low cost.

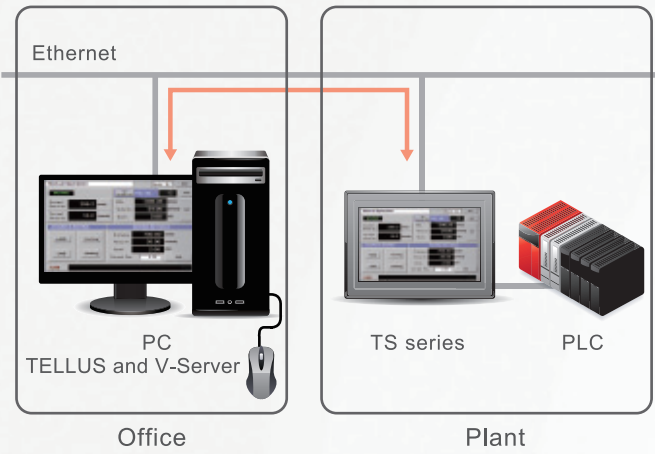

Application software for connecting your office and production sites at low cost

### TELLUS and V-Server

This software enables collection and management of production site information via the Internet in real time from your office in Japan or overseas.

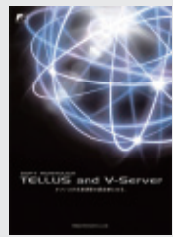

## 02 8-way Communication

Communication is available with up to eight kinds of devices consisting of PLCs and peripherals of different manufacturers through Ethernet or serial connection.

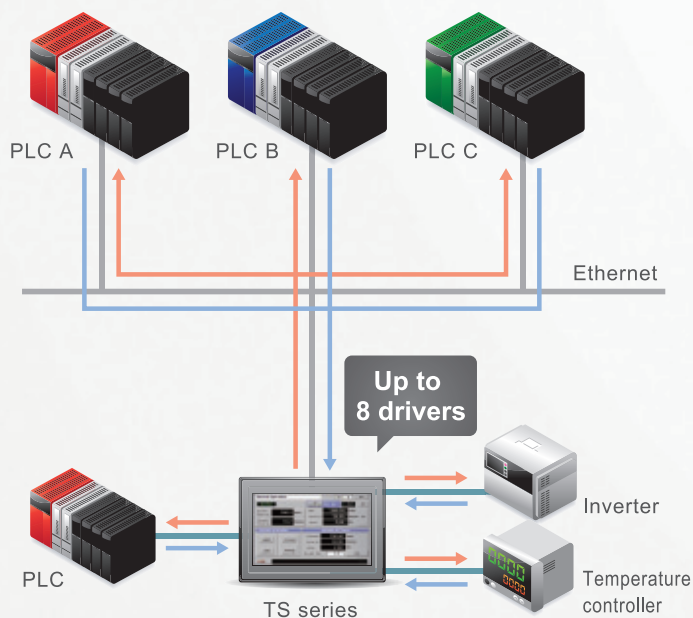

## 03 Path-through Programming

TECHNOSHOT allows you to write/read PLC ladder programs to/from your PC through Ethernet or USB connection.

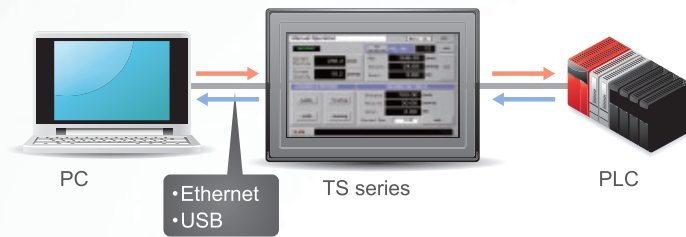

## 04 Multilanguage

You can change the language displayed on the screen to one of 16 languages. You need not manage files for each language.



Compatible language fonts:  
Japanese, English/ Western European, Chinese (traditional and simplified), Korean, Central European, Cyrillic, Greek, Turkish and Baltic.

## 05 Trend Sampling

Various kinds of data, which change from moment to moment, are recorded chronologically and shown in a trend graph.

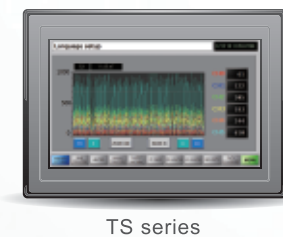

### Zoom Display

Magnification of a specified area allows you to check the waveform of the trend graph specifically.



## 06 Remote Desktop\* i series only

Screen on the server PC can be displayed and operated on a TS panel through Ethernet.

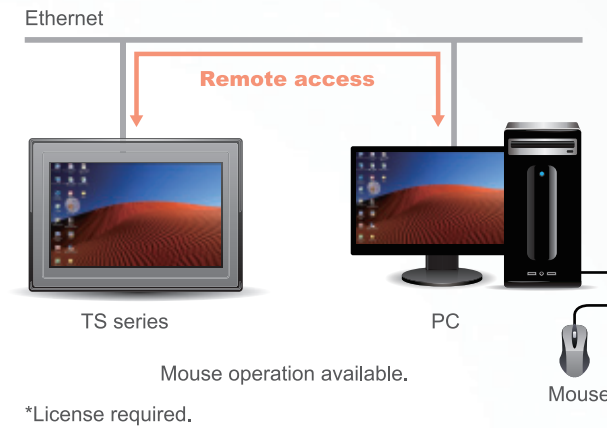

## 07 FTP Server i series only

Data in the USB thumb drive fitted to the TS panel can be read or written from/to the PC via FTP client tool.

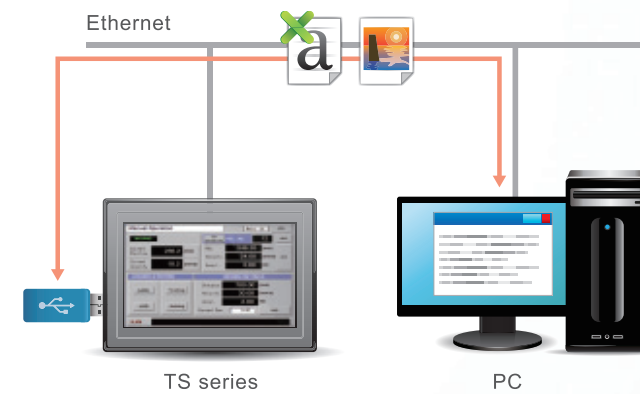

## 08 Operation Log

You can view log data for operations such as pushing of buttons and entering of values to check the "who/when/what/how" history and analyze the causes of failure.



## 09 Network Camera i series only

Images shot by network cameras can be displayed on a TS panel via Ethernet, which enables monitoring of production lines.

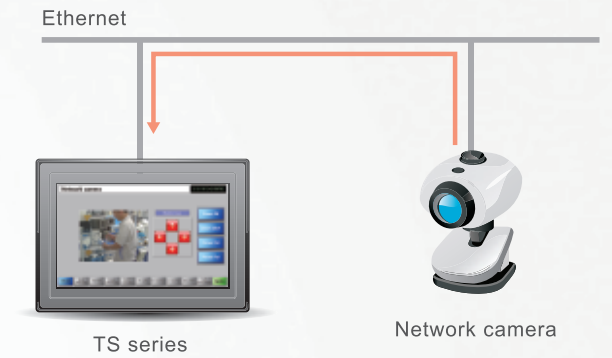

## 10 MES i series only

Various types of information such as production results and causes of failure and stoppage can be collected and saved in the database of the server through a TS panel and V-server.

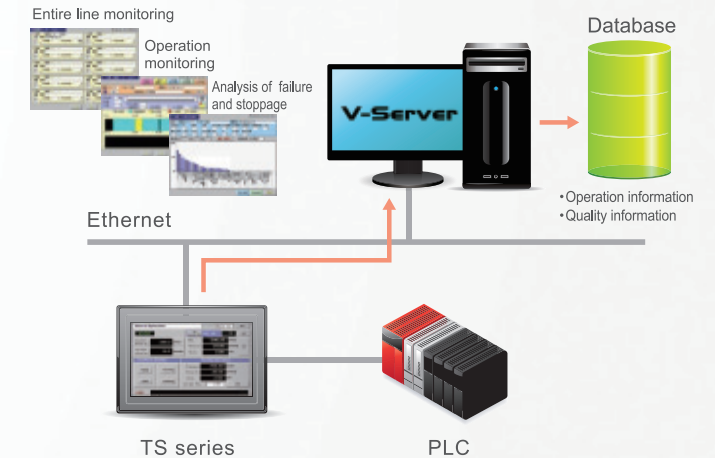

## 11 Security Function

By setting a function limit according to the user level, a high-security environment can be established.

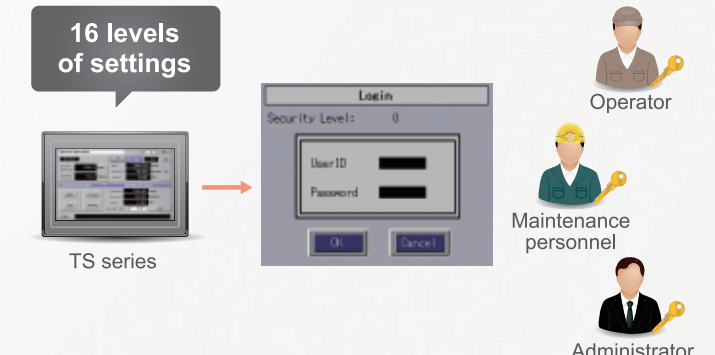



Facilitates screen configuration and maintenance with various functions

**MONITOUCH**  
**V-SFT** Ver. 5

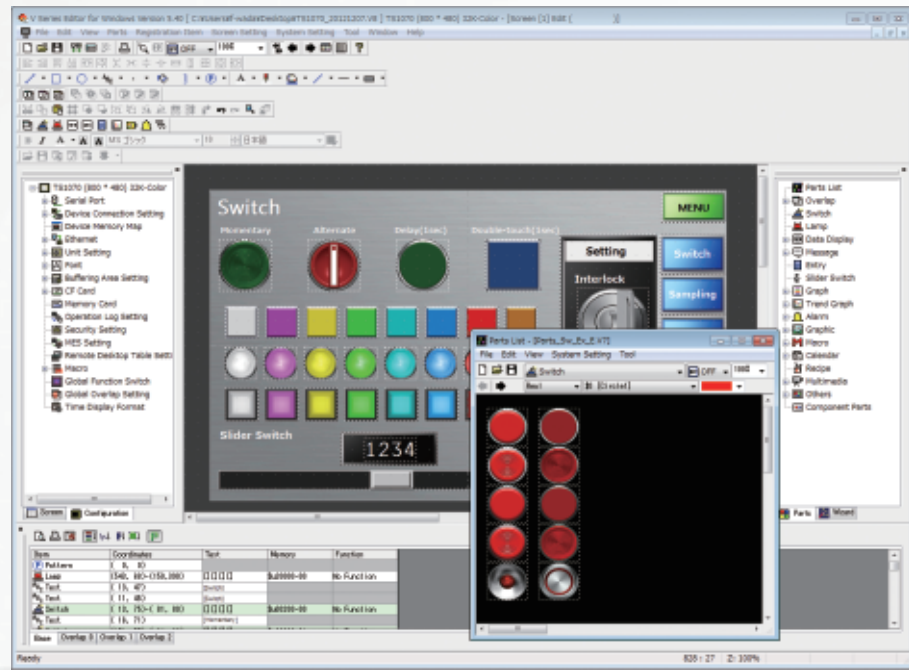

PC	PC/AT compatibles with Windows
OS	Windows98SE/ Me/ NT Version4.0/ 2000/ XP/ XP 64 Edition/ Vista 32bit/ Vista 64bit/ Win7 32bit/ Win7 64bit/ Win8 32bit/ Win8 64bit*
CPU	Pentium III 800MHz or higher (Pentium4 2.5GHz or higher is recommended.)
Memory	512MB or more
Hard disk	For installation: 1GB or more space required
CD-ROM disk drive	24 times or faster
Display	Resolution of 1,024 × 768 (XGA) or higher
Color indication	High color (16 bit) or higher
Note	Microsoft.NET Framework4.0 or 4.5 (Framework4.0 will be installed automatically in Windows XP/ Vista/ 7 PCs that do not have NET Framework4.0 or 4.5 already installed.)

\*For installing in Windows NT Version4.0/ 2000/ XP/ XP 64 edition/ Vista 32bit/ Vista 64bit/ Win7 32bit/ Win7 64bit/ Win8 32bit/ Win8 64bit, administrator authorization is required.  
\*TS series is compatible with Ver.5.4.28.0 or later.

## 01 Emulator

V-SFT Ver.5 allows debugging of the screen program on your PC.



## 02 Auto Resizing

Automatic resizing from QVGA (320×240) to WVGA (800×480). Previous screen program can be used without change.

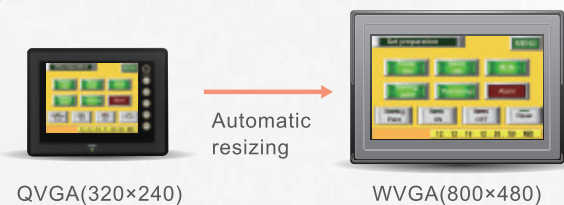

## 03 Function Switches Display\*

Function switches on the previous models can be added to the screen, and the screen program for the function switches can be used as well.



\*Two-step switch operation is not available.

Creating sophisticated screens by selecting parts with desired functions and macros.

## 01 Selection from Parts Library

You can easily create screens by selecting component parts from the parts library and arranging them.

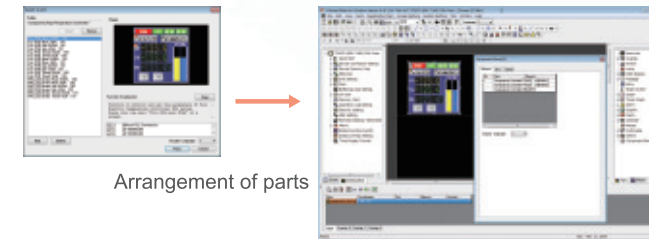

## 02 Addition to the Existing Program

Component parts can be easily added to the unused area in the existing screen program.

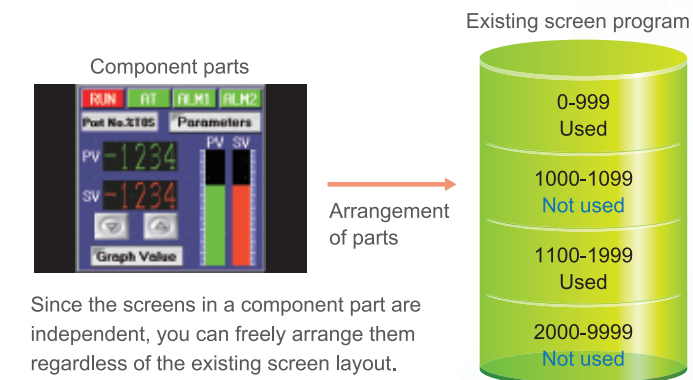

## 05 A variety of Component Parts

Component parts with various functions can be selected from the parts list to create screens according to your purpose easily.

<p>Temperature controller</p> <p>Screen for monitoring and parameter setting of temperature controllers</p>	<p>Inverter</p> <p>Screen for monitoring and parameter setting of inverters</p>	<p>Robot controller</p> <p>Screen for monitoring and operation setting of robots</p>	<p>I/O Monitor</p> <p>Screen to monitor PLC I/O</p>	<p>Calendar setting</p> <p>Screen for date setting of PLCs</p>
---	---	--	---	--

## 03 Screens Integrated in a Part

A component part consisting of some screens facilitates quick screen configuration.

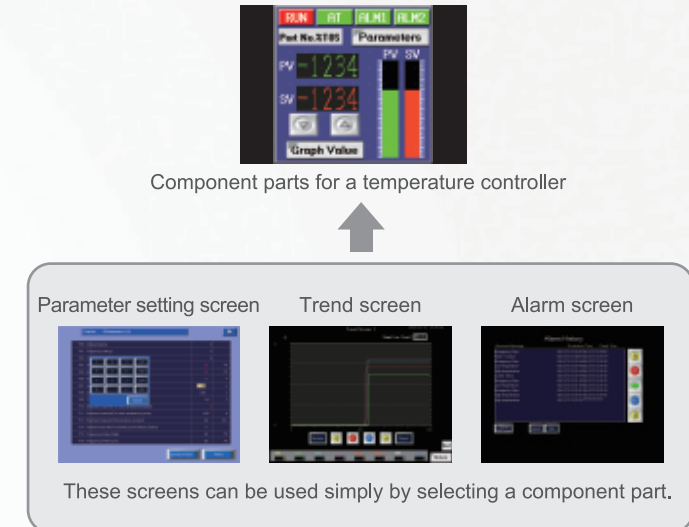

## 04 No Worry about Memory Shortage

Extra memory is provided for component parts separately from the memory for existing screens.

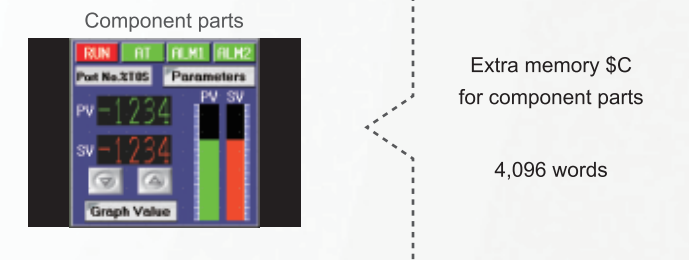

Optimum system configuration is available in accordance with type of business, site needs, environment, etc.

## TS1070 series (Unit: mm)

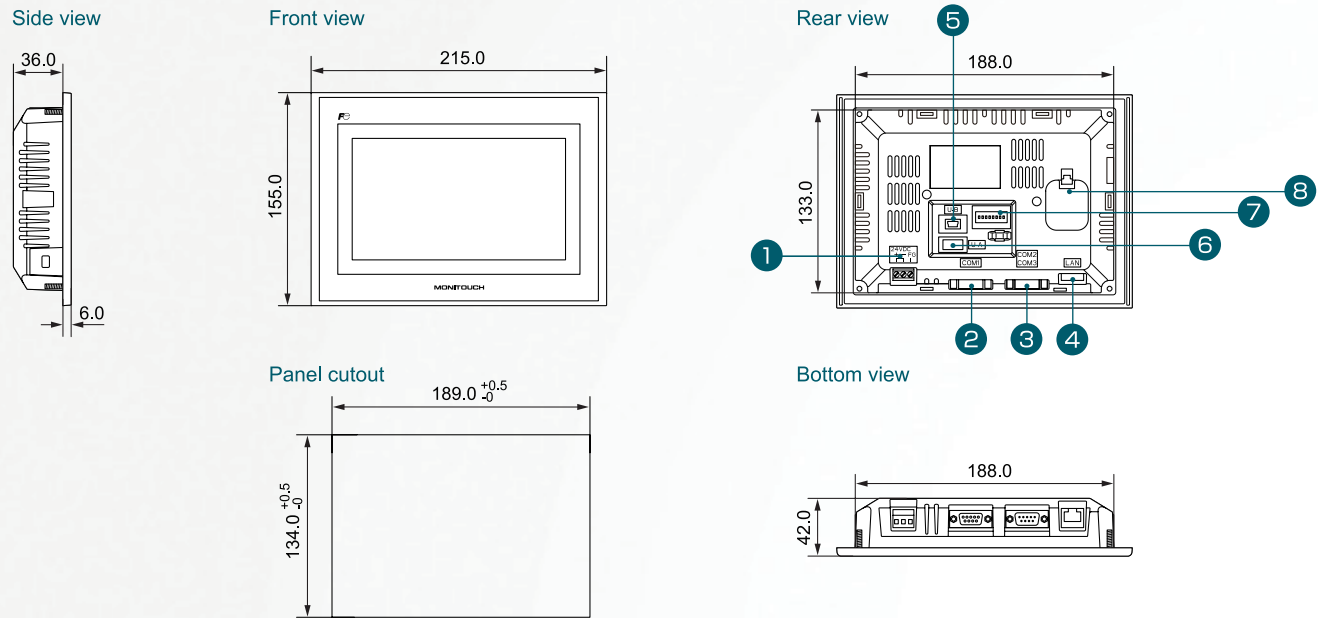

## TS1100 series (Unit: mm)

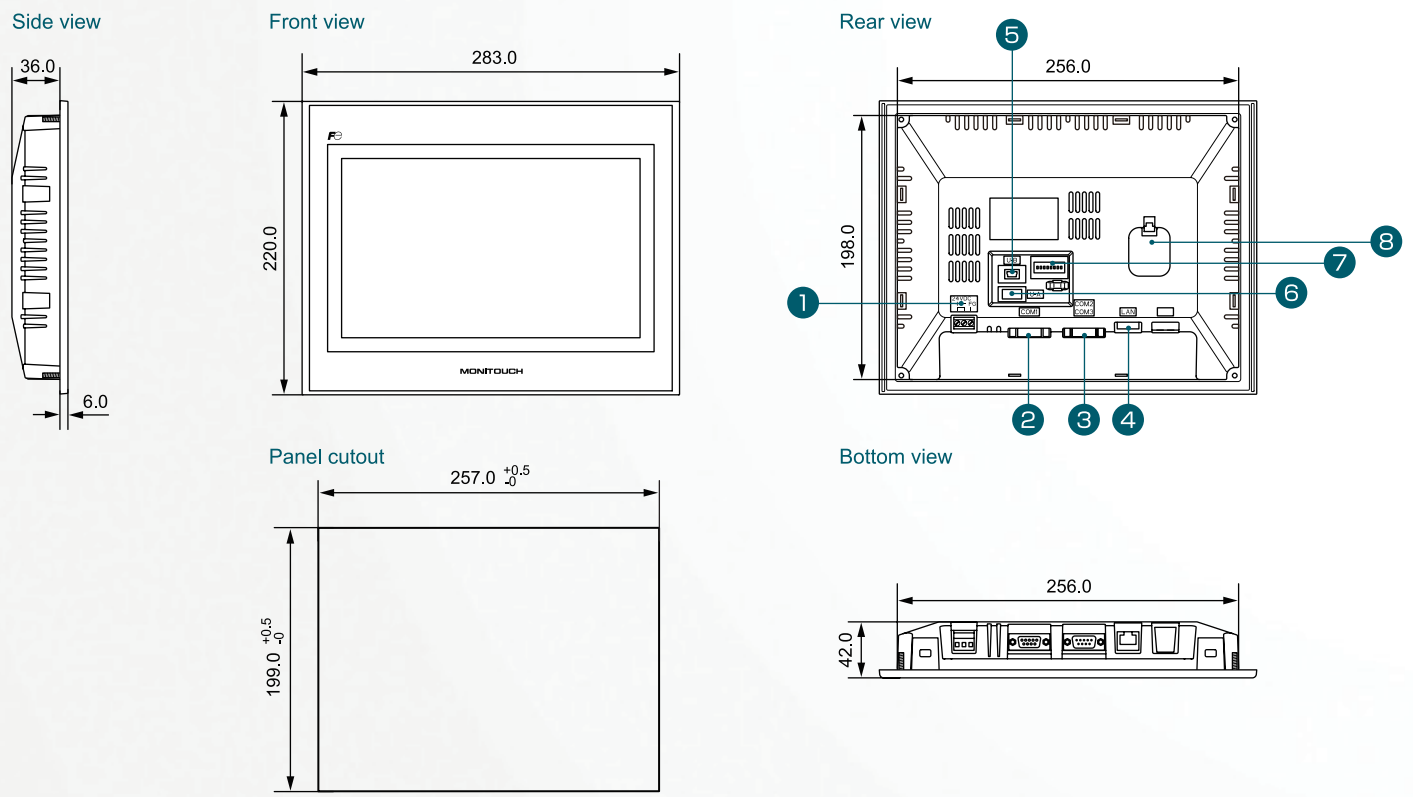

Part Names	
① Power supply terminal	⑤ USB slave (Type mini B)
② Serial D-sub 9-pin (COM1)	⑥ USB master (Type A)
③ Serial D-sub 9-pin (COM2/COM3)	⑦ DIP switch
④ 100BASE-TX/10BASE-T connector (LAN)	⑧ Battery

## Option

### V-SFT-5 (Configuration software)\*

Compatible OS:  
 Windows98SE/ Me/ NT Version4.0/  
 2000/ XP/ XP64 edition/  
 Vista 32bit/ Vista 64bit/  
 Win7 32bit/ Win7 64bit/  
 Win8 32bit/ Win8 64bit

\*TS series is compatible with Ver.5.4.28.0 or later.

### USB-CFREC (CF card recorder (USB))

Used for recording or reading data onto/from a CF card. Fitted on the control panel.

### TS1070-WP / TS1100-WP (Waterproof gasket)

Waterproof gasket for operation panels (used when waterproof level IP65 is required)

### UA-FR (USB-A port cable)

Cable to connect to the USB-A (slave) port.

## System Configuration

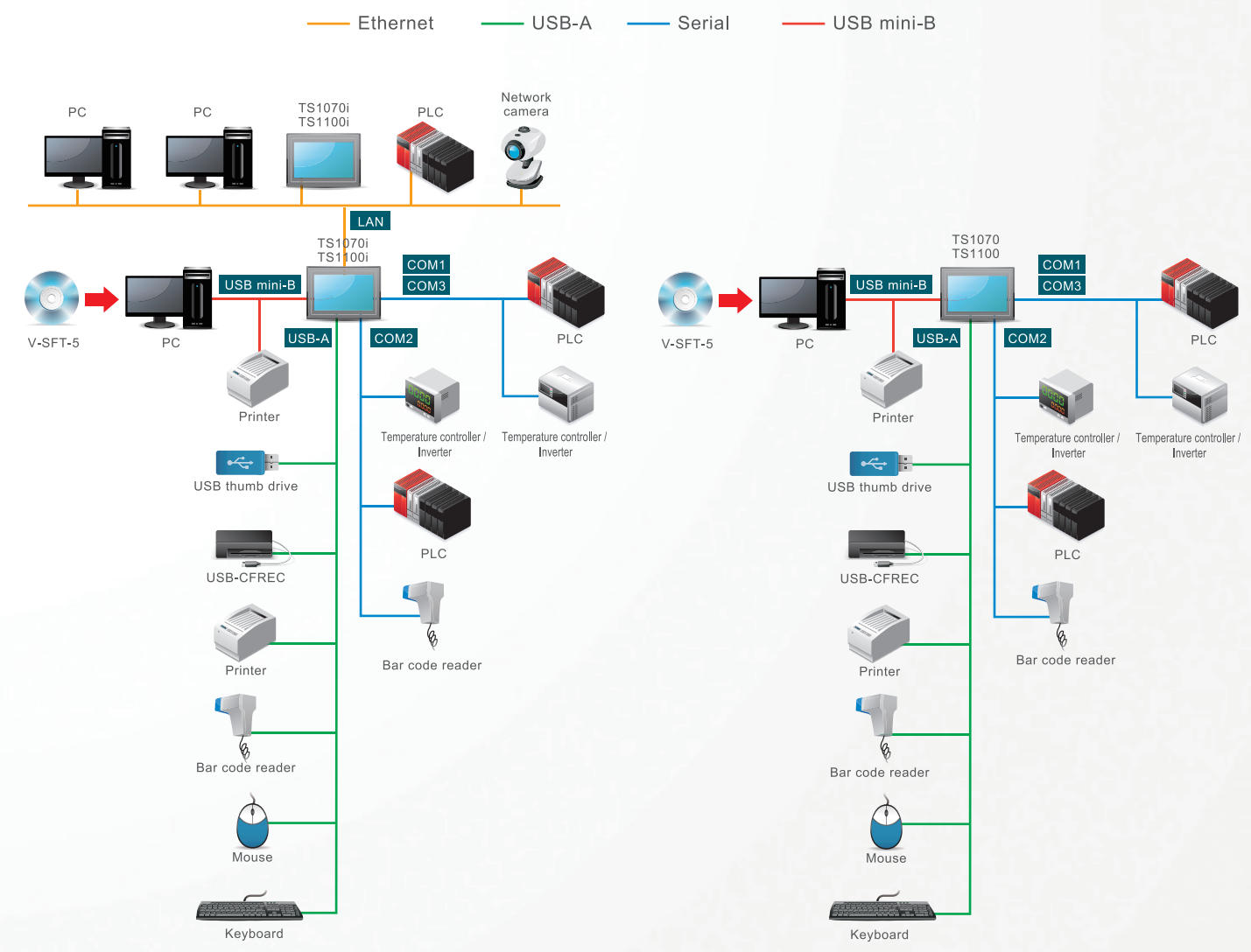

## Safety Considerations

- For safe operation, read the instruction manual or user manual that comes with the product carefully or consult the distributor from which you purchased the product, before using the product.
- Products introduced in this catalog have not been designed or manufactured for such applications in a system or equipment that will affect human bodies or lives.
- Customers, who want to use the products introduced in this catalog for special systems or devices such as for atomic-energy control, aerospace use, medical use, passenger vehicle, and traffic control, are requested to consult the Hakko Overseas Sales Section.
- Customers are requested to prepare safety measures when they apply the products introduced in this catalog to such systems or facilities that will affect human lives or cause severe damage to property if the products become faulty.
- For safe operation, wiring should be conducted only by qualified engineers who have sufficient technical knowledge about electrical work or wiring.

## Notes to consider before purchasing

- Appearance and specifications are subject to modification without prior notice due to technical improvements.
- Colors in the catalog may differ from the actual colors due to printing inaccuracies.
- Consult your distributor or us for further information about products in this catalog.

**[www.monitouch.com](http://www.monitouch.com)**

### Hakko Electronics Co., Ltd.

Overseas Sales Department  
238 Kamikashiwano-machi,  
Hakusan, Ishikawa 924-0035, Japan

- Tel  
+81-76-274-2144
- Fax  
+81-76-274-5136
- E-mail  
sales@hakko-elec.co.jp

Distributor

- \* Product specifications and design are subject to modification.
- \* Combined images are used for the screen images.
- \* Product colors may differ from colors in brochure photos due to printing.
- \* Windows and Excel are trademarks of Microsoft (USA) in the U.S. and other countries.
- \* Other company and product names in this brochure are registered trademarks.
- \* Printed with environment-friendly soy ink.

